

REV.	DESCRIPTION	ECN NO.	NAME	DATE
1	UPDATE THE DRAWING	N/A	WYJ	2018-03-23
2	NEW FRAME	N/A	JING	2020-06-20



ALL PARTS MUST MEET TO RoHS REQUIREMENTS

REMARKS:

- CONTACT PIN TO CLAMP

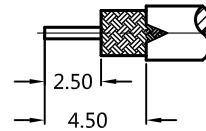

RECOMMENDED CABLE STRIPPING DIM'S

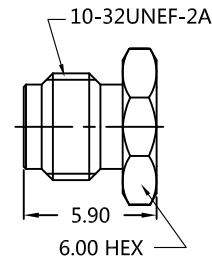
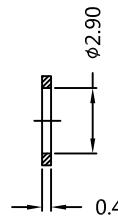
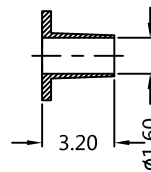
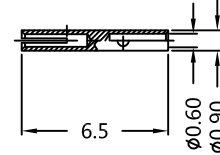
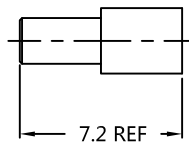
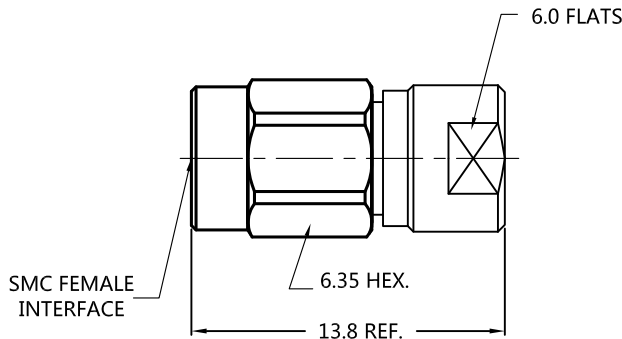

MATERIALS AND PLATING		UNIT: MICRO-INCHES
PART NAME	MATERIALS	PLATING
BODY/SHELL	BRASS C3604	GOLD 3u" / NICKEL/COPPER
INSULATOR	TEFLON MIL-P-19468	N/A
CONTACT PIN	BE-CU C17300	GOLD 5u" / NICKEL/COPPER
FERRULE	BRASS C3604	GOLD 3u" / NICKEL/COPPER
NUT	BRASS C3604	GOLD 3u" / NICKEL/COPPER

ELECTRICAL CHARACTERISTICS	
IMPEDANCE	50 Ω
VOLTAGE RATING	250 V(rms)
FREQUENCY RANGE	0 ~ 10 GHz
DIELECTRIC WITHSTANDING VOLTAGE	>750 V
CONTACT RESISTANCE	CENTER CONTACT
	OUTER CONTACT
INSULATION RESISTANCE	>1000 MΩ
INSERTION LOSS	According as the cable
RF-LEAKAGE	N/A
VSWR	<1.35 @ 3 GHz
3RD INTERMODULATION	N/A

MECHANICAL CHARACTERISTICS	
FORCE TO ENGAGE AND DISENGAGE	N/A
CENTER CONTACT RETENTION FORCE	N/A
RECOMMENDED COUPLING TORQUE	30-50 in-lbs
COUPLING NUT RETENTION FORCE	>35 lbs
DURABILITY	>500 cycles

ENVIRONMENTAL PARAMETER	
TEMPERATURE RANGE	-65°C ~ +165 °C

* CUSTOMER OUTLINE DRAWING

UNLESS OTHERWISE SPECIFIED:
 1) EDGES : C0.15 MAX ;
 2) REMOVE ALL BURRS ;
 3) SURFACE ROUGHNESS : Ra1.6 ;
 4) UNITS : mm ;
 5) DIMENSIONS TOLERANCES
 DECIMALS : .x ±0.3 .xx ±0.2 .xxx±0.1;
 ANGLES : ± 5°.

THIRD ANGLE PROJECTION

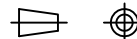

APPROVED :

CUSTOMER P/N :

CHECKED :

SCALE :

3 : 1

DRAWING :

JING

DATE : 2020-06-20

PAGE : 1/1



TITLE : SMC ST FEMALE FOR RG-316 CABLE 50Ω

DRAWING NO. :

5AMM11S-A02-003

COMPANY WEBSITE : www.slkcorp.com

CUSTOMER OUTLINE DRAWING